

Ship control in manoeuvring situations with fuzzy logic controllers

L. Morawski

Gdynia Maritime University, Gdynia, Poland

V. Nguyen Cong

Vietnam Maritime University, Haiphong, Vietnam

ABSTRACT: In this paper, the ship control regulator in manoeuvring situation is presented. It consists of three fuzzy logic controllers. Each controller controls one of motions: turning, transverse and longitude motion of a ship. The regulator is built in the simulink of Matlab with the graphical interface. All experiments are performed in the Matlab environment with the ship simulation.

1 INTRODUCTION

Nowadays, many vessels are equipped with thrusters to support the manoeuvring activities. They are very useful for manoeuvring activities in narrow place but the controlling many thrusters at the same time is a challenge to the helmsman. Therefore, a regulator, which controls all propulsion system to perform the tasks in manoeuvring situation, is very necessary. This problem has been examined by many researchers using different methods, for different vessel's propulsion kinds, and as a consequence, obtaining different results (Broel Plater B. 1998, Passino K., 1998).

This article will introduce a regulator, which controls three propellers: bow thruster, stern thruster and main propeller to carry out the recently tasks in manoeuvring such as moving vessel on a set path with set heading, turning vessel at a fixed point and so on. The algorithm of regulator and results of experiments on simulation computer with scale model in the real environment will be presented in detail in the next sections.

2 THE OBJECT OF CONTROL

The training ship "Blue Lady" is the autonomous scale model of the VLCC tanker. It is used by the Foundation for Safety of Navigation and Environment Protection at the Silm Lake near Ilawa in Poland for training navigators. The vessel is built of the epoxies resin laminate in 1:24 scale. It is equipped with battery-fed electric drives and the control steering post at the stern. The model is

equipped with the main propeller, rudder, two tunnel thrusters, two azimuth pump thrusters which can be rotated to the limited angles. The regulator presented in this paper just controls two tunnel thrusters and main propeller for manoeuvring tasks. The arrangement of the model is shown in Figure 1 and main characteristic data in Table 1.

Table 1. The main characteristic data of the model

Length over all LOA	13.78[m]
Beam B	2.38[m]
Draft (average) - load condition T ₁	0.86[m]
Displacement - load condition D	22.83[T]
Speed	3.10[kn]

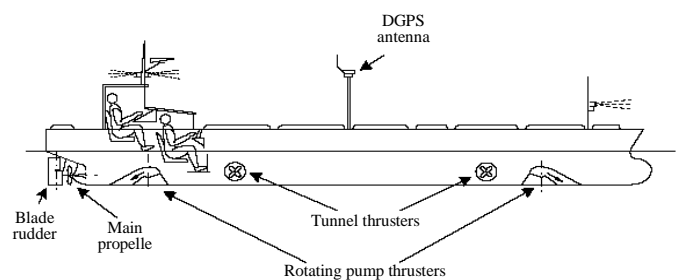

Fig. 1. The arrangement of the model "Blue Lady"

3 THE REFERENCE FRAMES AND DEFINITIONS

There are two reference frames used in control. They are Geographic reference frame ($x_n y_n$) and Body reference frame (Figure 2).

Geographic Reference Frame ($x_n y_n$ or n -frame): The coordinate system $x_n y_n$ is defined relative to the Earth reference ellipsoid (World Geodetic System 1984). In this coordinate system the x -axis points towards true North, while the y -axis points towards East (Fosen T.I., 2002).

Body Reference Frame ($x_b y_b$ or b -frame): This is moving coordinate frame which is fixed to the vessel. The origin O_b of the coordinate system is chosen to coincide with the center of gravity (CG) when CG is in the principal plane of symmetry. The axes are defined as x - longitudinal axis, directed from aft to fore and y - transversal axis, directed to starboard (see Figure 2) (Fosen T.I., 2002)

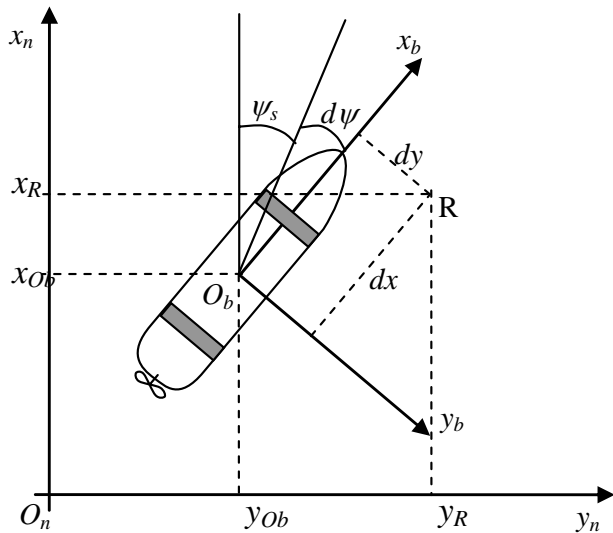

Fig. 2. Reference frames

- R – reference point, required position of the vessel
- dx – position deviation in x-axis of b-frame
- dy – position deviation in x-axis of b-frame
- ψ_s – set heading
- $d\psi$ – course deviation

The position of vessel is fixed by GPS in n -frame while the signals for control (deviations) are measured in b -frame. The transfer functions of coordinates and velocities between these frames as following:

$$\begin{bmatrix} x_b & y_b & \psi_b \end{bmatrix}^T = R_b^n \begin{bmatrix} x_n - x_{Ob} & y_n - y_{Ob} & 0 \end{bmatrix}^T \quad (1)$$

$$\begin{bmatrix} u & v & r \end{bmatrix}^T = R_b^n \begin{bmatrix} \dot{x}_n & \dot{y}_n & \dot{r} \end{bmatrix}^T$$

where

$$R_b^n = \begin{bmatrix} \cos \psi & -\sin \psi & 0 \\ \sin \psi & \cos \psi & 0 \\ 0 & 0 & 1 \end{bmatrix}^{-1} \quad (2)$$

Reference point R: This is a point on which the vessel position has to be maintained. The vessel movement will be controlled through this point.

4 ALGORITHM OF CONTROL

4.1 Control forces and characteristic of the controller

In this regulator, the controlling forces have the form of pulses. Its magnitude is changed by steps and plays the role of rough controlling while the acting time is adjusted continuously and play the role of fine controlling. By this control method, the vessel responds quickly to the affect of the environment. The relation of controlling force, deviations and vessel dynamic character is displayed in the Equations 3. In these equations, the values “0”, “small”, “medium” and “big” are control force magnitude levels, which are fixed with step values in the controllers.

The controllers used in this regulator are fuzzy logic controller, Mamdani type. To create the control signals (controlling force) in the pulse, the membership functions of controllers must have narrow shape, not intersectional and the defuzzification of controllers must be biosector type. It is shown detail in the Section 5.

$$\begin{cases} \Delta t = f_{\Delta t}(\varepsilon_\eta, \dot{\varepsilon}_\eta) \\ \bar{F} = f_{\bar{F}}(\varepsilon_\eta, \dot{\varepsilon}_\eta); \bar{F} = \{0; \pm \text{small}; \pm \text{medium}; \pm \text{big}\} \\ \dot{\varepsilon}_\eta = f_{\text{dynamic}}(m, \tau, F, \varepsilon_\eta) \end{cases} \quad (3)$$

where

- Δt – acting time of control force
- \bar{F} – magnitude of control force
- ε_η – errors; $\varepsilon_\eta = [dx, dy, d\psi]$
- m – mass of control object
- τ – forces act on the control object

4.2 Control vessel movement

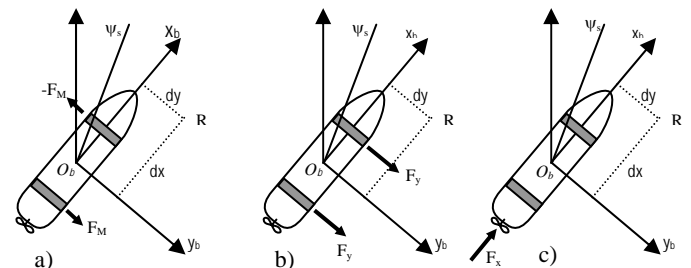

Fig. 3. The forces in control vessel
a) Control heading

- b) Control side-moving
- c) Control longitudinal moving

The regulator has three fuzzy logic controllers. They are course keeping, x-position keeping and y-position keeping controller. Three controllers work together to maintain the vessel position at the reference point R with the set course ψ_s .

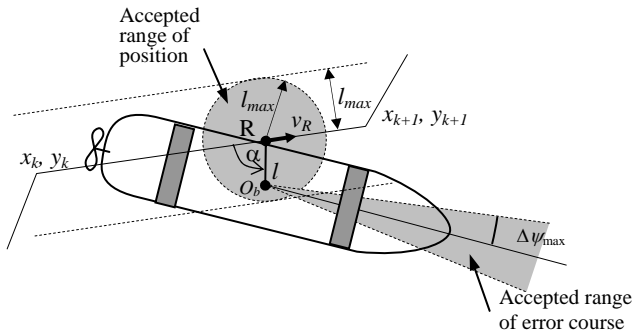

Fig. 4. Moving reference point R along the set path

Because the controllers always keep the vessel position stable at the reference point R so when the coordinates of reference point are changed, the vessel position is also changed. Hence, the movement of vessel (track and speed) can be controlled by changing coordinates of reference point R. However, the power of propellers is limited so the vessel can not follow the reference point if it moves too fast. Hence, the movement of reference point R is also depend on the actual status of the vessel. The algorithm of control reference point R movement is presented as following.

Assume that the accepted range of error course is $\Delta\psi_{max}$ and the accepted range of deviation position is l_{max} (Figure 4). The reference point R is just moved forwards when all above deviations are in the accepted range. If error course and/or deviation position are greater than accepted range, the reference point is stopped to wait for the controllers stabilize the vessel at set heading and reference position. The flowchart in Figure 5 shows the algorithm of controlling reference point R.

In the flowchart, (x_k, y_k) and (x_{k+1}, y_{k+1}) are coordinates of two waypoints of the path segment. The variable v_R is the set speed on the set path segment; it is also the set speed for referent point R. The angle α is used to determine the relative position of vessel to reference point R.

When vessel moves stable with $l < l_{max}$, it means the vessel has speed as same as reference point speed. When l is equal or a bit greater than l_{max} : 1) if $\alpha < 90^\circ$, it means vessel speed is lower than speed of the reference point ($V < v_R$). In this case, the moving forward of reference point is restrained by the vessel movement. It can be imaged as the reference point R pulls the vessel by a rope, which has the length l_{max} (Figure 6a). 2) If $\alpha > 90^\circ$, it means the vessel speed V

is faster than speed of reference point R ($V > v_R$). In this situation, the reference point R can move with its set speed v_R . The controller tries to curb the moving forward of vessel to keep the deviation position less than l_{max} . It can be imaged as the reference point R pulls the vessel back to reduce the vessel speed to set speed v_R (Figure 6b)

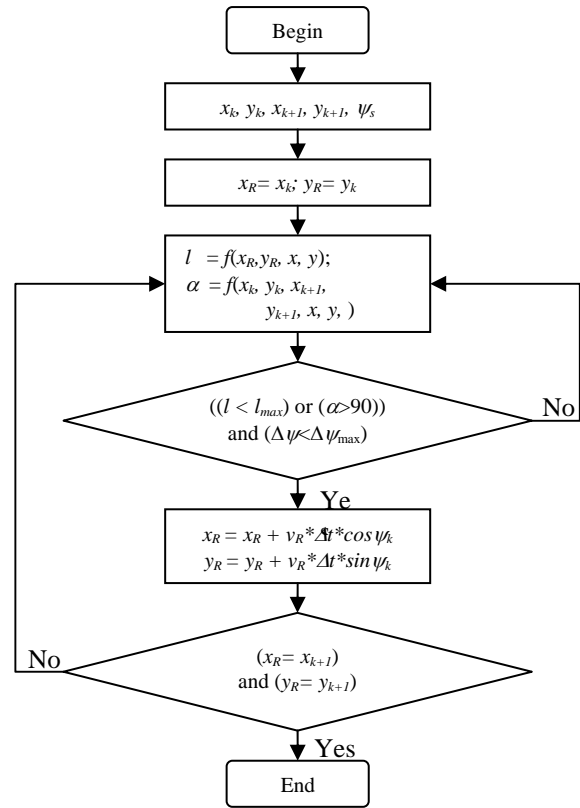

Fig. 5. Algorithm of moving reference point R

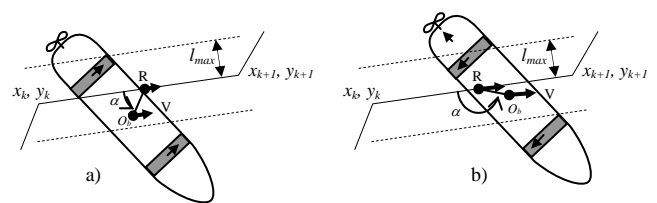

Fig. 6. The relative position of reference point R and actual position of vessel O_b

5 THE REGULATOR

The diagram of the regulator is shown on the Figure 7. The database of a set path, it is a records set of path segment, is stored in *Data of trajectory* block. The information of a path segment consists of coordinates of two waypoints, set heading and set

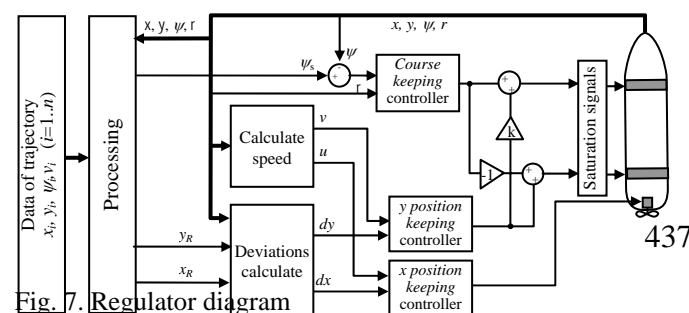

Fig. 7. Regulator diagram

speed. The data of the path segments are sent to the *Processing* block one by one in proper time. Basing on actual data of the vessel x , y , ψ , r and data of current path segment, the *Processing* block controls the movement of reference point R with the algorithm presented in Section 4.2.

The *Calculate speed* block calculates the surge u and sway v speed of vessel from the difference positions of vessel in every second. The Kalman filter is used in this block to reduce the noise and abnormal signals. The *Deviations calculate* block calculate the distances from vessel to the reference point R. These deviations, in fact, are coordinates of reference point R in the Body frame b -frame. The control signals to the thrusters are sum of signals from *Course keeping* controller and y -position keeping controller so they may be out of range of thruster's input. To avoid this, the control signals are processed by the *Saturation signals* block before sending to thrusters. This block processes these signals so that they are always in the input ranges of thruster and their characters are as same as the resultant signals of two these controllers.

Table 2. Fuzzy logic controllers' properties

FIS type	Mamdani
# Inputs	2
# Outputs	1
AND method	min
OR method	max
Defuzzification	biosector
Implication	min
Aggregation	max

The three controllers are fuzzy logic type (Passino K., 1998). They have same properties as shown in Table 2 and their membership function and rules are presented in the next paragraphs.

Course keeping controller: This controller controls the bow thruster and stern thruster to keep the vessel heading stably at the set heading. To fulfill this task, the controller has to maintain the heading error and turning rate at the value of 0. Due to this, the inputs membership functions are established symmetrically around 0 (Figure 8). The first input is heading error $\Delta\psi$. Its range is $[-180^\circ +180^\circ]$. When heading error is in the range $[-30^\circ +30^\circ]$, the controller controls the heading with different rules depending on situations. When heading error is greater than $+30^\circ$, the controller controls the heading with the rules for error heading $+30^\circ$. It is similar for the case heading error is less than -30° . The second input is turning rate. Its input range is set to covers range of turning rate of common vessels. In practice, this range is $[-1^\circ/s +1^\circ/s]$. In the case, the rate of turn is out of that

range, the controller controls by the rules for turning rate r of $-1^\circ/s$ or $+1^\circ/s$.

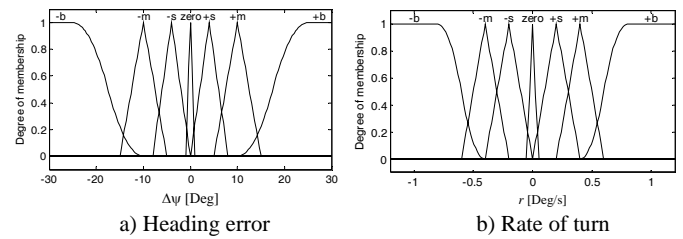

Fig. 8. Inputs membership functions of the *Course keeping* controller

The output membership functions and rules are shown in the Figure 9. The levels are $\pm s$, $\pm m$ and $\pm b$ respective to 1/3, 2/3 and full power of the thruster. The level $\pm s$ is used to stabilize vessel course. The level $\pm m$ is used to turn vessel when the error course is less than $\pm 15^\circ$. The level $\pm b$ is used to accelerate and turning vessel when error course is greater than $\pm 15^\circ$.

This controller controls two thrusters (bow and stern). Both control signals to these thrusters are same amplitude but opposite sign (see Figure 7).

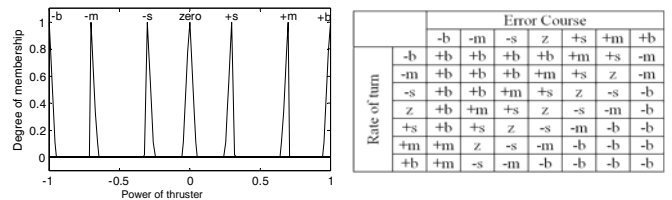

Fig. 9. Output membership functions and table of rules of the *Course keeping* controller

y position keeping controller: This controller controls side moving of vessel. The task of the controller is keeping vessel position closest reference point in y axis of b -frame. Two inputs consist of dy deviation (m), sway v (m/s) with membership functions are shown in Figure 10. The input ranges are established basing on the dimension of vessel. The model Blue Lady has 2.38 m in breadth so the range of y deviation is set in $[-5m +5m]$. It is approximate 4 times of the Blue Lady width. In addition, the main task of the controller is to maintain the vessel close to the reference point. It means the y deviation is maintained around the value 0. Due to these, the membership functions are symmetry at 0 as shown in Figure 10.

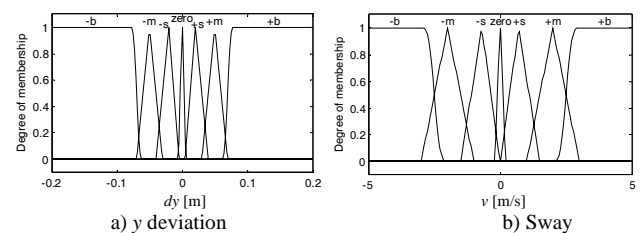

Fig. 10. Inputs membership functions of y position keeping controller

The output membership functions and rules of the controller are shown in the Figure 11. The effect of bow and stern thrusters are different in side moving control so the signals sent to thrusters are set with ratio k in the gain block (Figure 7). The ratio k is chosen that to minimum the changing course of vessel when she moves to side by its thrusters.

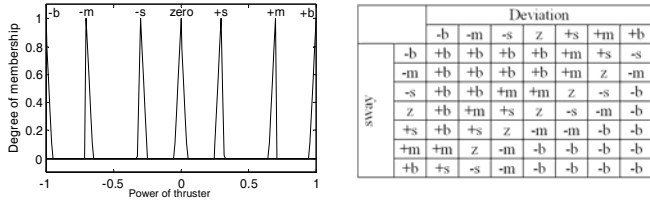

Fig. 11. Output membership functions and table of rules of y position keeping controller

x position keeping controller: This controller controls the longitudinal moving of vessel. The task of the block is keeping vessel position closest reference point in x axis of b -frame. The membership functions of the controller have nine zones. Seven of them (from $-b$ to $+b$) are proportional to the membership functions of y position keeping controller. Two others ($-vb$ and $+vb$) are used in the case of braking up vessel when vessel has speed higher than its maneuvering speed.

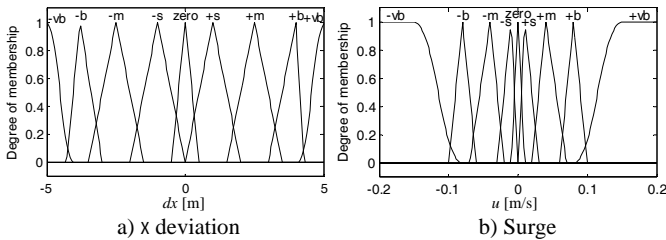

Fig. 12. Membership functions of inputs

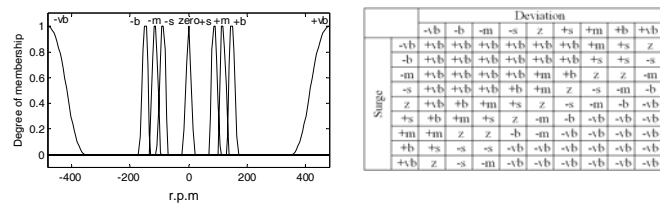

Fig. 13. Output membership functions and table of rules of x position keeping controller

In maneuvering situation, the movement in every direction is same priority. So the output signals of the x position keeping controller in levels $\pm b$, $\pm m$ and $\pm s$ must correspond to respective levels of y position keeping controller. Beside it, the vessel hull is designed with priority in longitudinal moving so the resistance in this direction is small hence to brake up vessel needs high power. Levels $+vb/-vb$

with full engine ahead/astern is reserved for this task.

6 EXPERIMENTS AND RESULTS

Four experiments have been presented in this section. They show the results of control vessel movement in: 1) Oblique movement (longitudinal and transverse at the same time), 2) Longitudinal/Transverse movement and 3) Special trajectory shape.

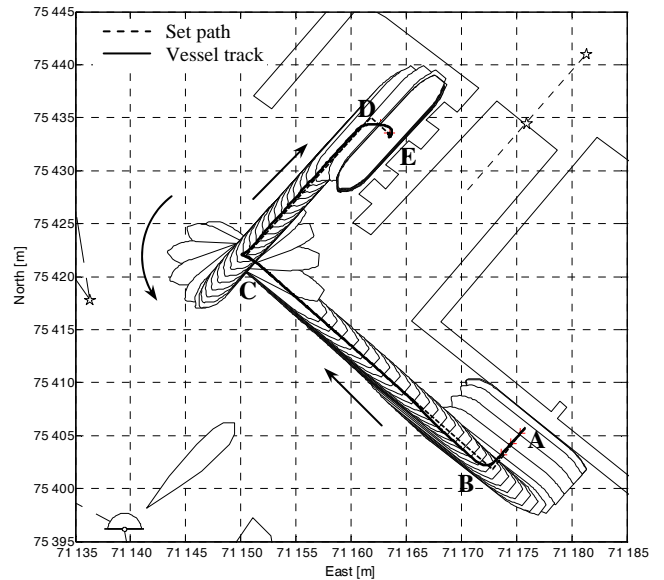

Fig. 14. Vessel track of the experiment No.1. (plotting every 10s)

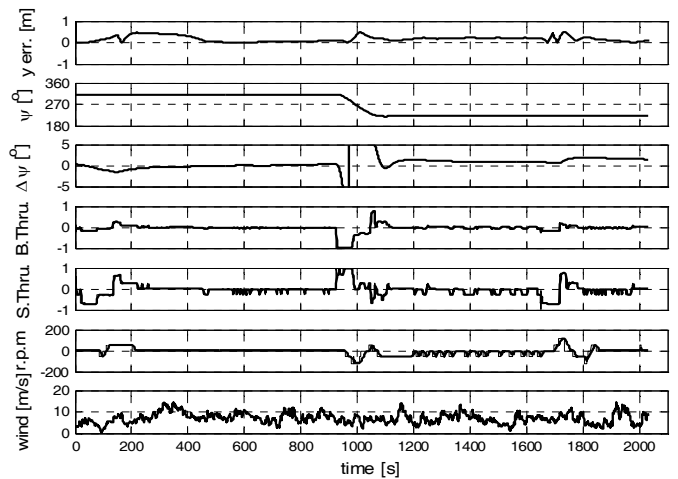

Fig. 15. Recorded data of the experiment No. 1

The experiment No. 1 was carried out to evaluate the control in a single transverse/longitude movement and the turning model at a waypoint. The model left from the quay (Point A), performed side movement in segment AB. Then, it moved forward in segment BC. At point C, it turned 90° and then ran astern in segment CD. In the last segment DE, the model moved transversely and contacted to the second quay.

The position deviation, error course are shown on the Figure 15. The maximum value of cross deviation was 0.5m, less than a quarter of the model's width. The model turned 90° at the waypoint C in 200s and did not have any oscillation after turning (see Figure 15).

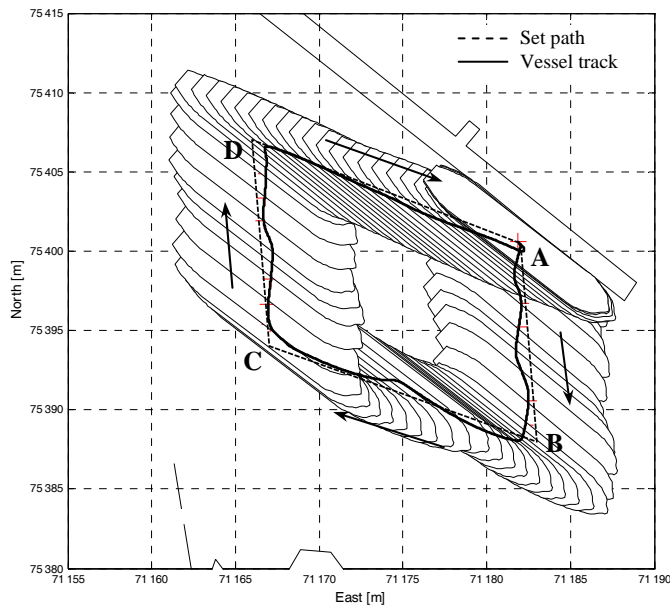

Fig. 16. Vessel track of the experiment No. 2 (plotting every 10s)

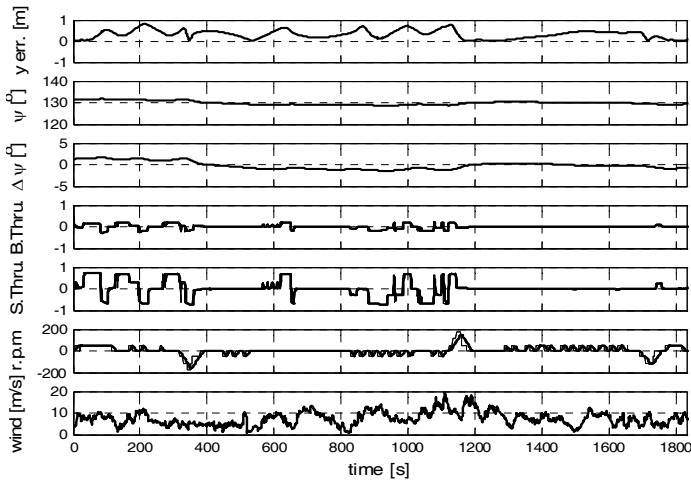

Fig. 17. Recorded data of the experiment No. 2

Experiment No. 2 was carried out to evaluate the oblique movement. In this experiment, the model was controlled to move in aft-port (AB), in fore-port (BC), in fore-starboard (CD) and in aft-starboard (DA) direction (Figure 16)

Comparing the results of experiment No.1 and No.2, the accuracy of position control in oblique movement was worse than it in transverse/longitude movement. This caused by the difference between the characteristic of main engine and thruster of the vessel. The main engine is more powerful but it responds very slowly in changing its mode. The main engine simulated on Blue Lady is turbine type.

It takes several dozen seconds (in model scaled) to change from the ahead engine mode to the astern engine mode. On the contrary, thrusters are very weak but respond very quickly. Therefore, it is very difficult to combine main engine and thrusters in the oblique movement.

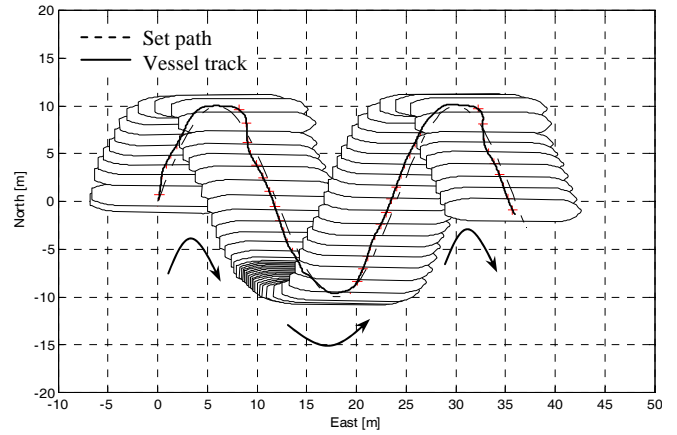

Fig. 18. Vessel track of the experiment No. 3 (plotting every 60s)

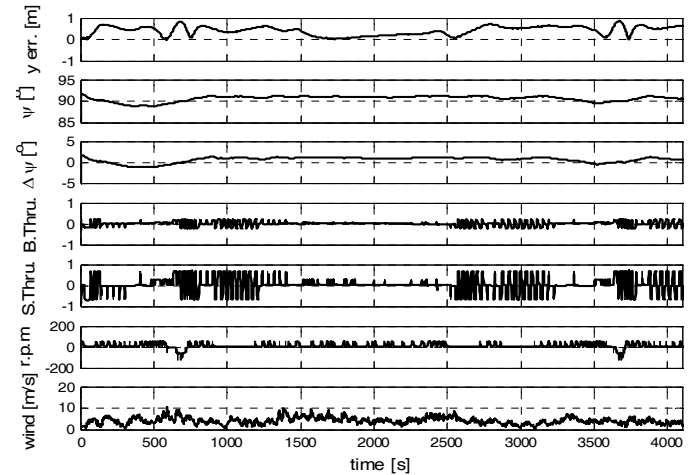

Fig. 19. Recorded data of the experiment No. 3

In the experiment No. 3 and No. 4, the model was controlled with the special set path. The set path is not segment lines as in the experiment No. 1 and No. 2, they have the shape of the sin function and spiral line.

7 CONCLUSIONS

The ship control regulator was tested with all of the movements in manoeuvring situation: transverse, longitude movement, oblique movement, turning at a fix position. Moreover, the movements with special shape of the trajectory such as function sin, spiral line, were performed in the experiments.

In all experiments, the position deviations were always less than a half of the vessel's wide; the error heading was always less than 3° .

According to experiments' results, it can be considered that the regulator satisfies with the control ship in manoeuvring situations.

REFERENCES

- Broel, Plater B, 1998, Fifth International Symposium on Methods and Models in Automation and Robotics 'Fuzzy control for vessel motion', pp. 697-702, Poland, 25-29 August.
- Fosen T.I., 2002. *Marine Control Systems*. Marine Cybernetics, Trondheim, Norway.
- Gierusz W., 2001. In Proceedings of Int. IFAC Conf. Control Applications in Marine 'Simulation model of the shiphhandling training boat Blue Lady', Glasgow, Scotland, UK, 18-20 July.
- Grimble M.J., 2000. *Industrial Control Systems Design*. JohnWiley and Sons, Chichester.
- Passino K., 1998. *Fuzzy Control*, Longman.
- The Mathworks Inc., 2005. *Fuzzy Logic Toolbox User's Guide*. The Mathworks Inc., Natick, MA

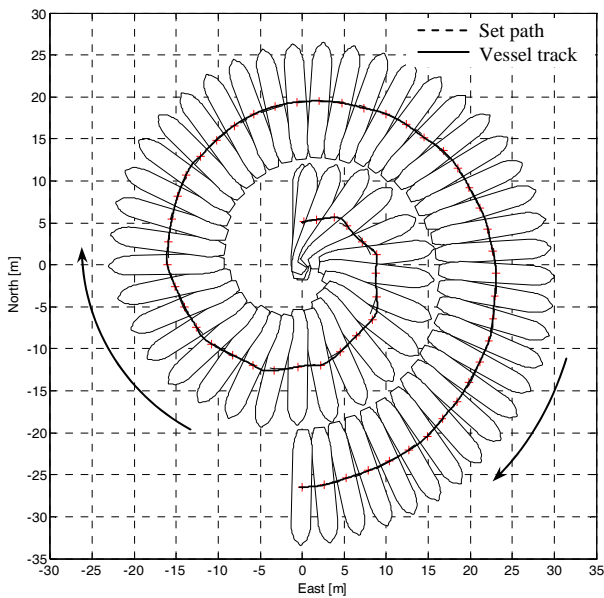

Fig. 20. Vessel track of the experiment No. 4 (plotting every 60s)

In the experiment No. 3, the model was controlled to move on the path, which has the shape of function sin. The heading of the vessel was set at fixed value 90° . According to the recording data of the experiments (Figure 19), the accuracy of position and heading in the experiment No. 3 are same as the accuracy of them in the experiment No. 2.

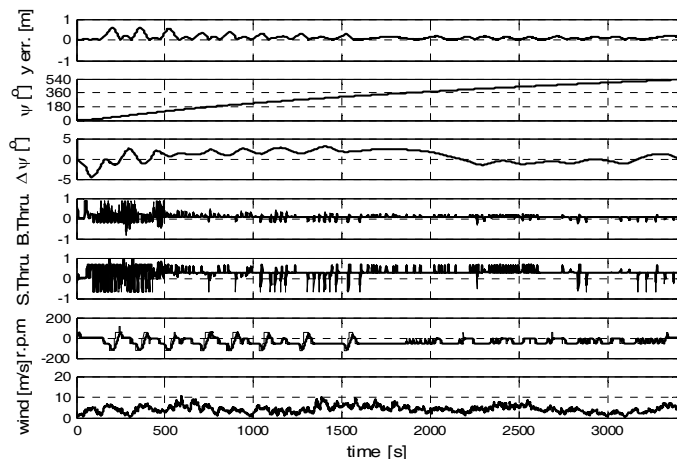

Fig. 21. Recorded data of the experiment No. 4

In the experiment No. 4, the model was moved on the spiral path. The vessel was moved changing course from 0° to 540° (Figure 20). The radius was increased from 5m to 26.6m. When vessel was close to the center of spiral path (small radius), the thrusters were working harder; the deviations of position and heading were also lager. In contrary when vessel was far from center, the thrusters were working more easily and these deviations were smaller (Figure 21).